

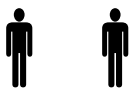







|  |   |   |
|--|---|---|
|  45 MIN |  |  |
|--|---|---|

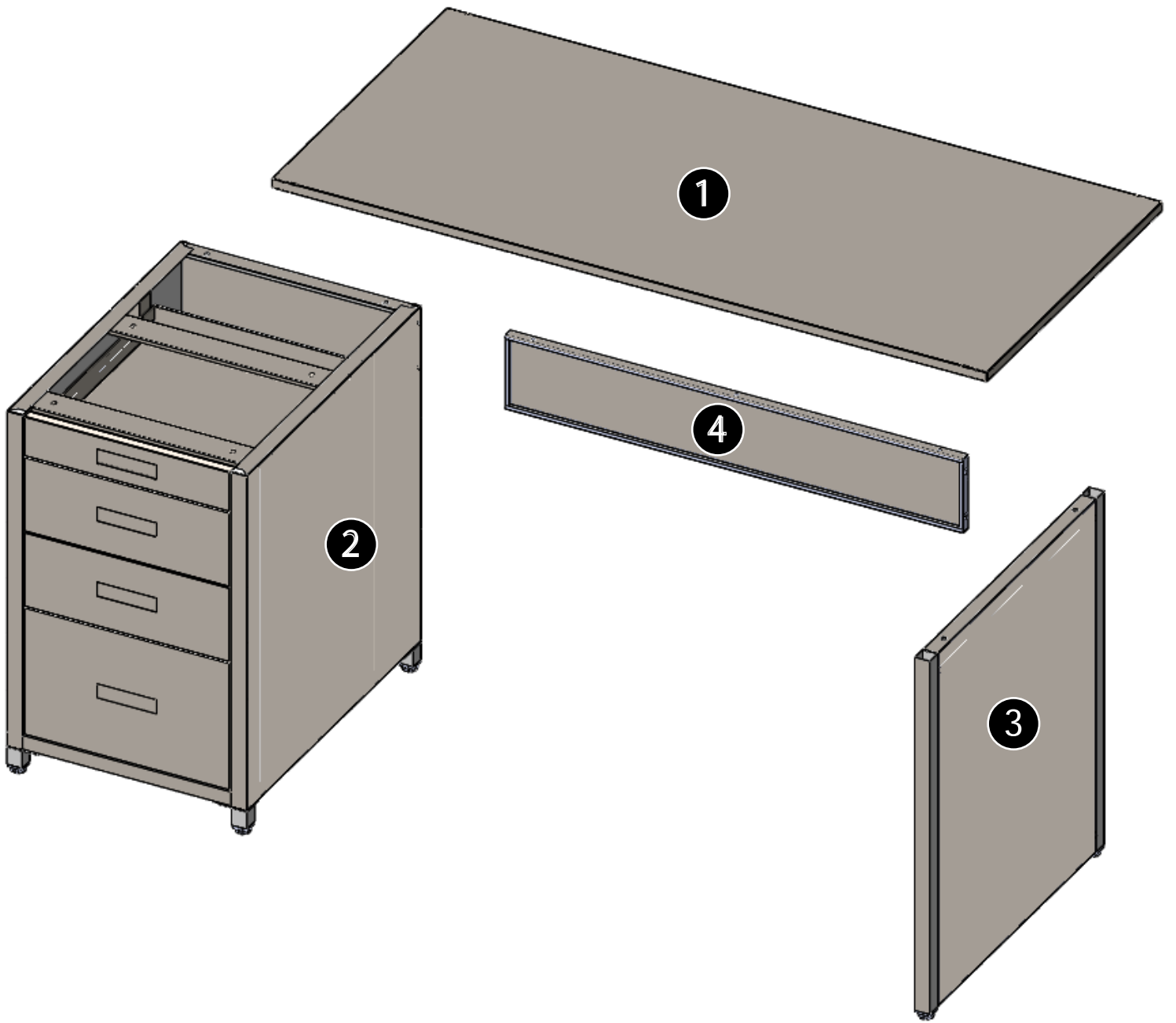

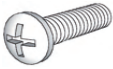
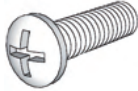
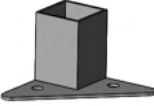
|   |  |  |  |   |
|---|--|--|--|---|
| <p><b>A</b></p>  <p>Ø5X12mm    x15</p> | <p><b>B</b></p>  <p>Ø6X16mm    x8</p> | <p><b>C</b></p>  <p>Ø6X40mm    x2</p> |  <p>x4</p> |  <p>x4</p> |
|---|--|--|--|---|

