

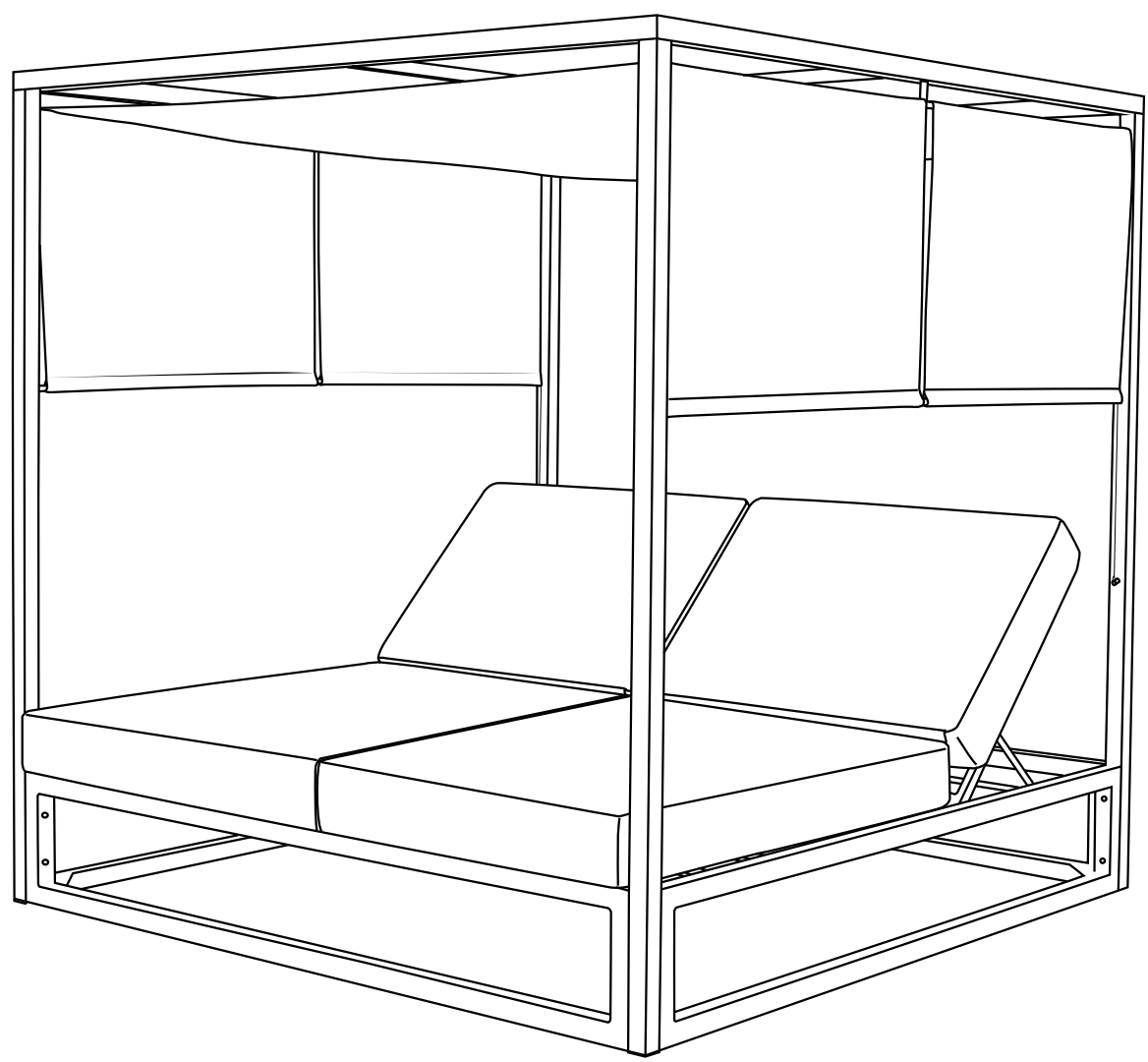

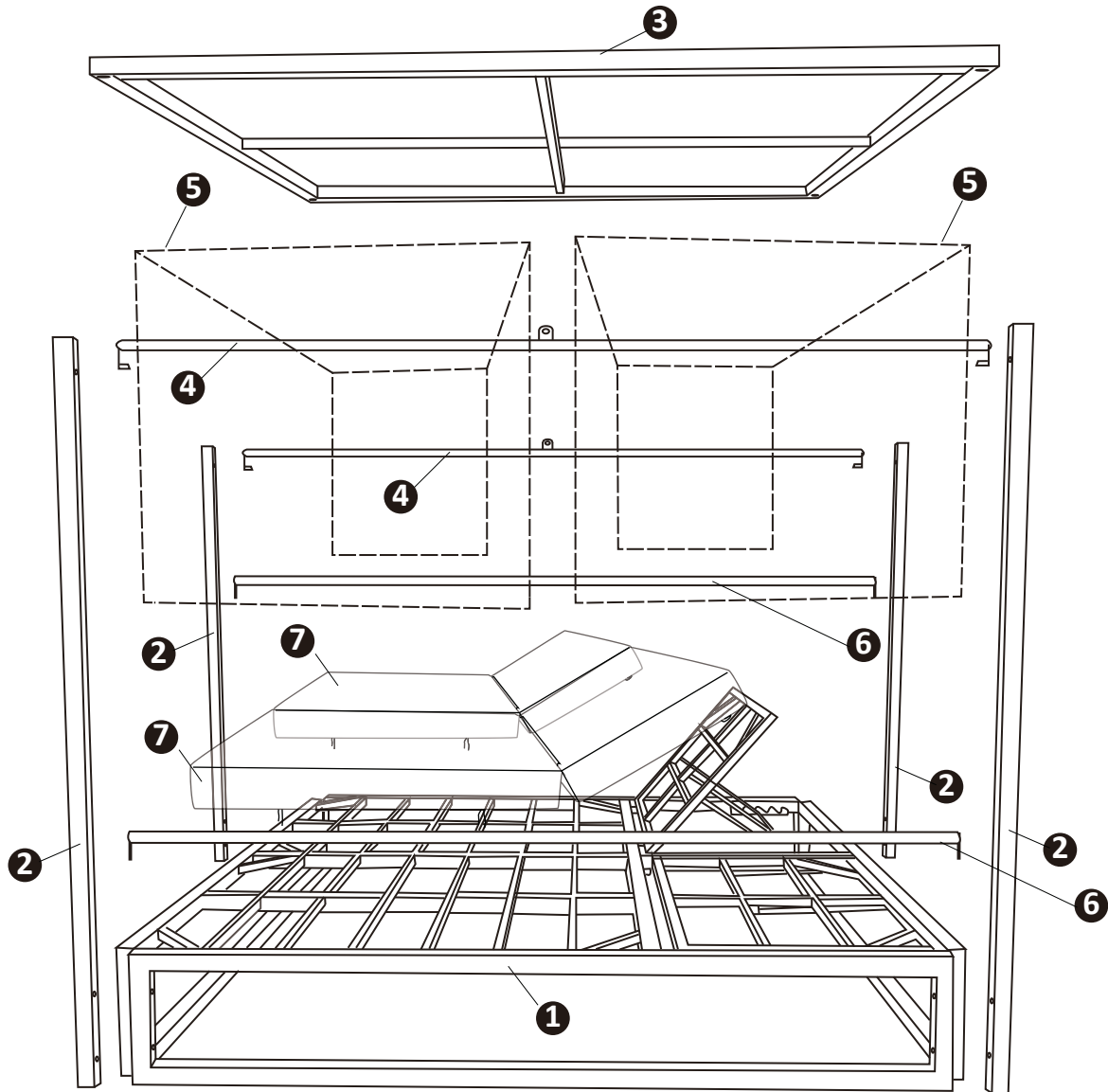



# CARAIBES



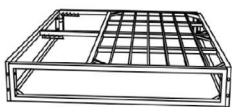

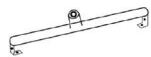





175172



 60 MIN	
--	---



 <p><b>1</b></p> <p>x 1</p>	 <p><b>2</b></p> <p>x 4</p>	 <p><b>3</b></p> <p>x 1</p>	 <p><b>4</b></p> <p>x 2</p>	 <p><b>5</b></p> <p>x 2</p>	 <p><b>6</b></p> <p>x 2</p>	 <p><b>7</b></p> <p>x 2</p>
---	--	--	--	---	--	--





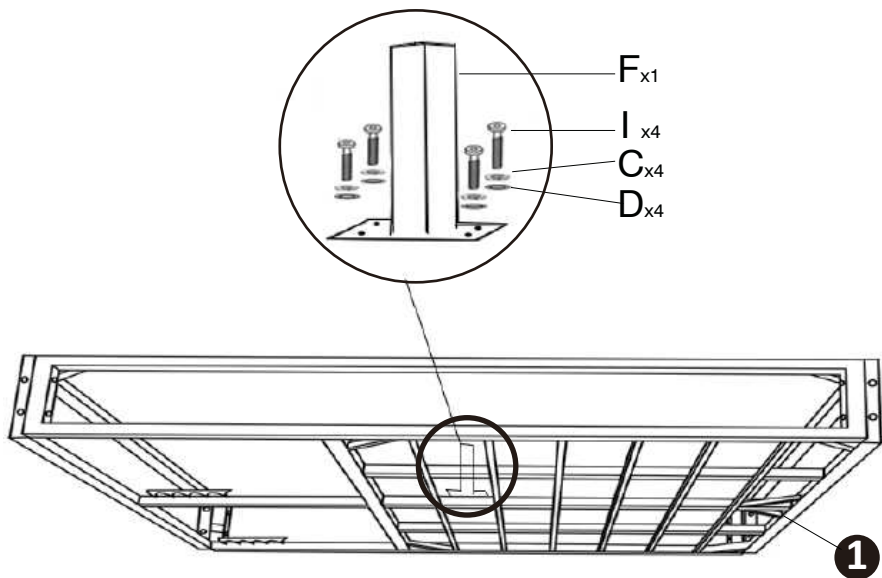

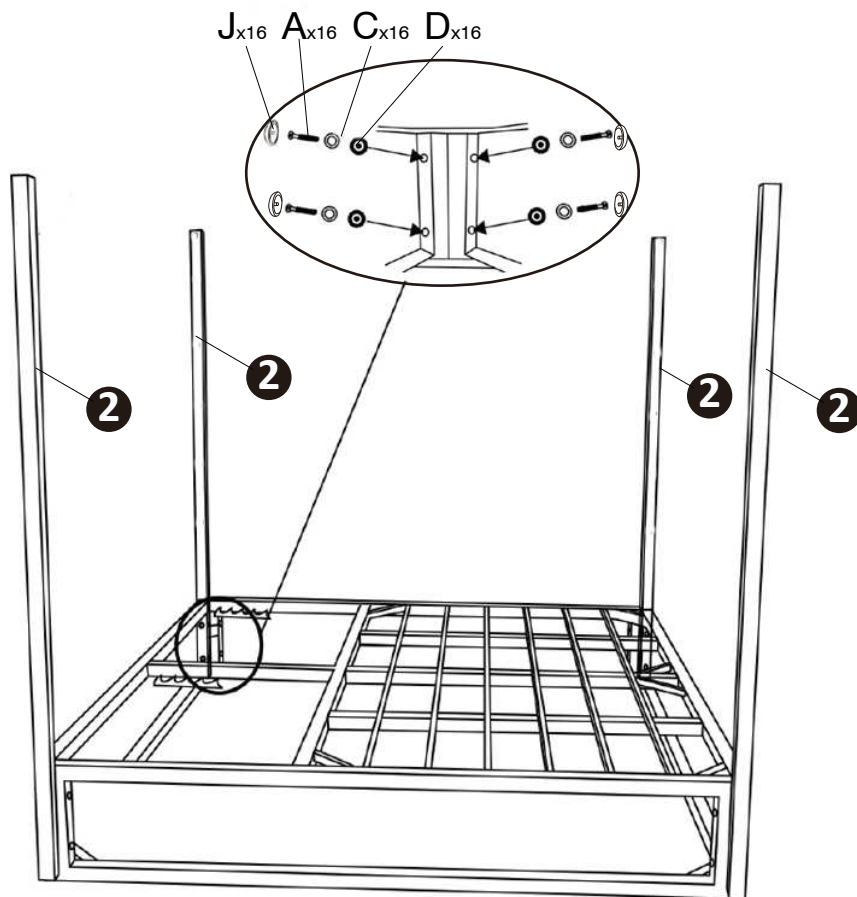

 <p>A</p> <p>M6X60MM</p> <p>x 22</p>	 <p>B</p> <p>M6X40MM</p> <p>x 4</p>	 <p>C</p> <p>DIA6.5X1.6MM</p> <p>x 34</p>	 <p>D</p> <p>DIA6.5X1.0MM</p> <p>x 34</p>	 <p>E</p> <p>BTR 4MM</p> <p>x 1</p>	 <p>F</p> <p>x 1</p>	 <p>G</p> <p>x 4</p>	 <p>H</p> <p>BTR</p> <p>x 4</p>	 <p>I</p> <p>M6X20MM</p> <p>x 8</p>	 <p>J</p> <p>x 22</p>	 <p>K</p> <p>BTR</p> <p>x 1</p>
--	--	--	--	--	---	--	--	--	--	--

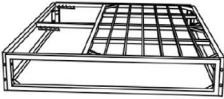
1



2



<b>1</b>  x 1	<b>2</b>  x 4	<b>A</b>  M6X60MM x 16	<b>C</b>  DIA6.5X1.6MM x 20	<b>D</b>  DIA6.5X1.0MM x 20	<b>E</b>  BTR 4MM x 1	<b>F</b>  x 1	<b>I</b>  M6X20MM x 4	<b>J</b>  x 16
---	--	--	---	---	--	--	---	---

3

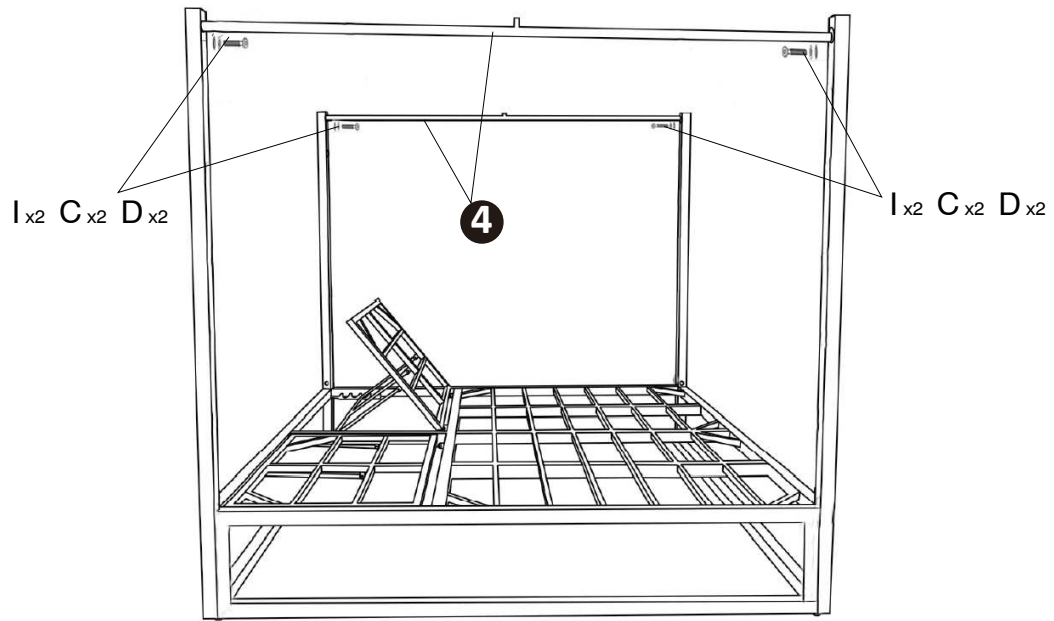

4

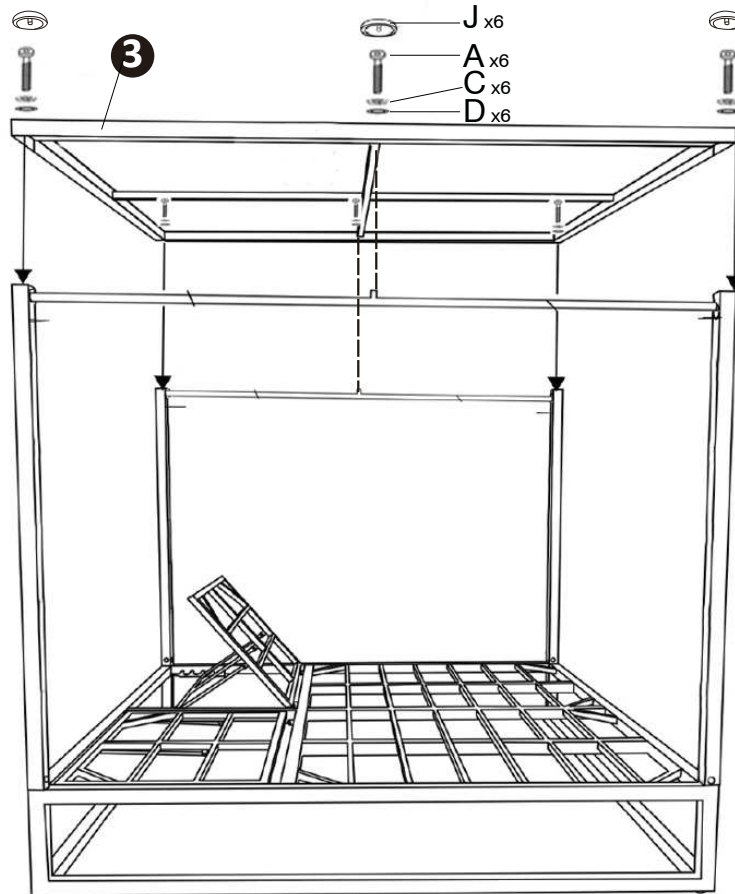





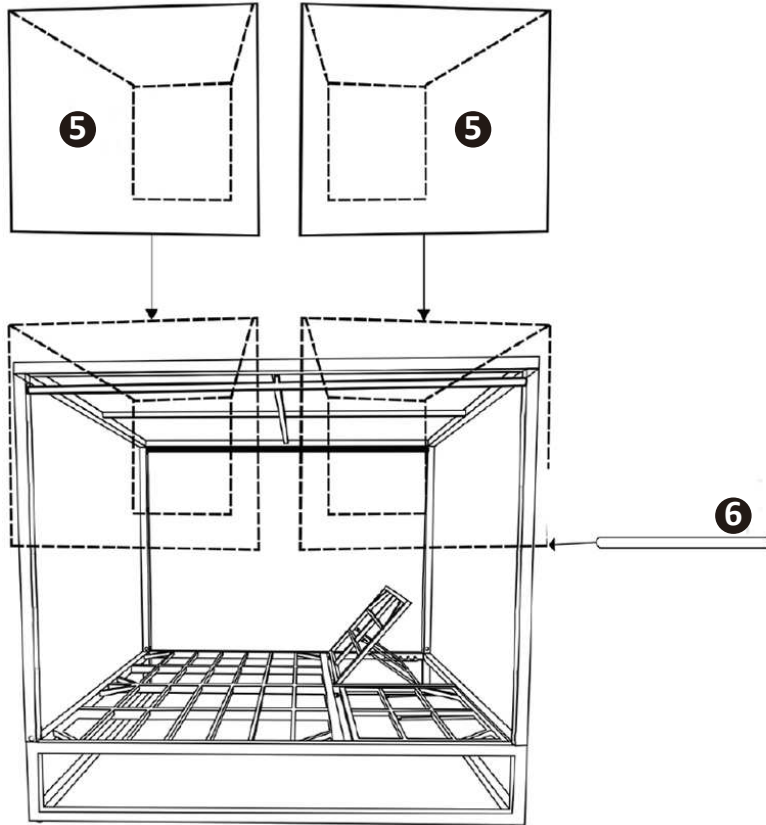

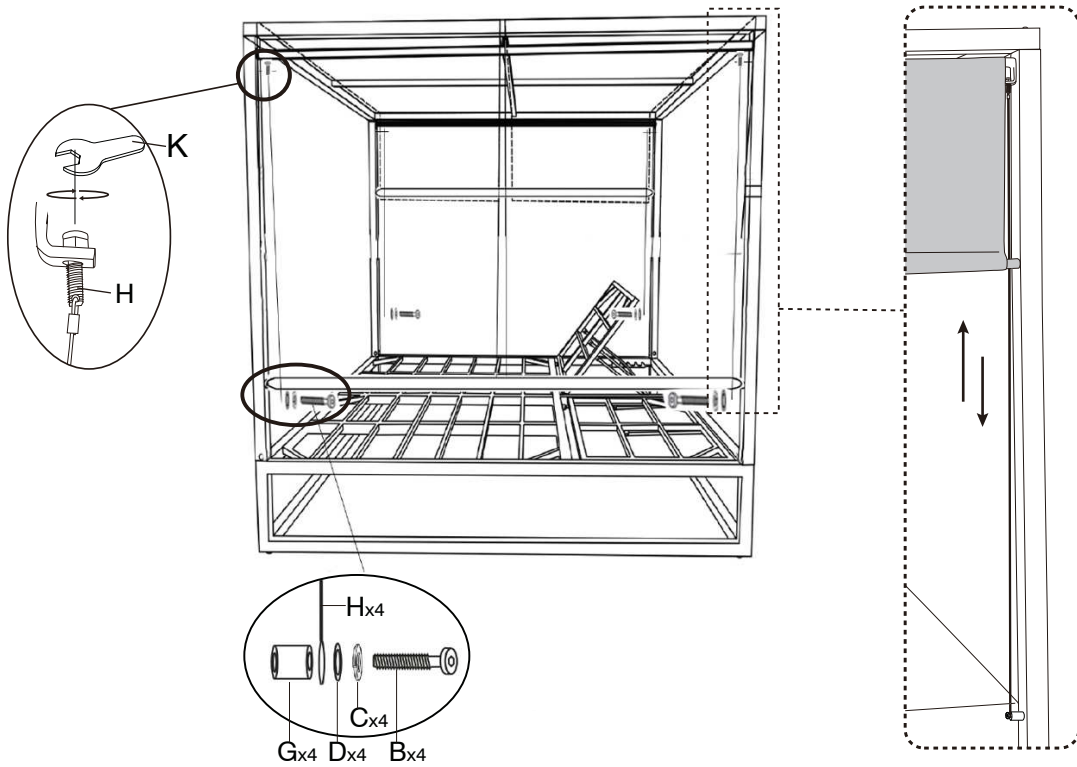

<p><b>3</b></p> <p>x 1</p>	<p><b>4</b></p> <p>x 2</p>	<p><b>A</b></p> <p>M6X60MM x 6</p>	<p><b>C</b></p> <p>DIA6.5X1.6MM x 10</p>	<p><b>D</b></p> <p>DIA6.5X1.0MM x 10</p>	<p><b>E</b></p> <p>BTR 4MM x 1</p>	<p><b>I</b></p> <p>M6X20MM x 4</p>	<p><b>J</b></p> <p>x 6</p>
----------------------------	----------------------------	--	--	--	--	--	----------------------------

5



6



<p><b>5</b></p>  <p>x 2</p>	<p><b>6</b></p>  <p>x 2</p>	<p><b>B</b></p>  <p>M6X40MM x 4</p>	<p><b>C</b></p>  <p>DIA6.5X1.6MM x 4</p>	<p><b>D</b></p>  <p>DIA6.5X1.0MM x 4</p>	<p><b>G</b></p>  <p>x 4</p>	<p><b>H</b></p>  <p>BTR x 4</p>	<p><b>K</b></p>  <p>BTR</p>
--	--	--	---	---	---	--	--

7

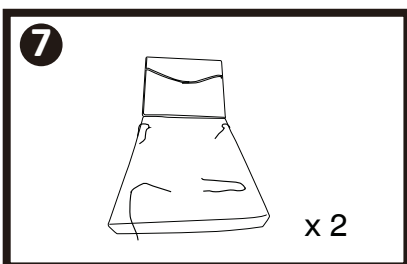
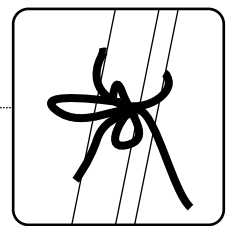
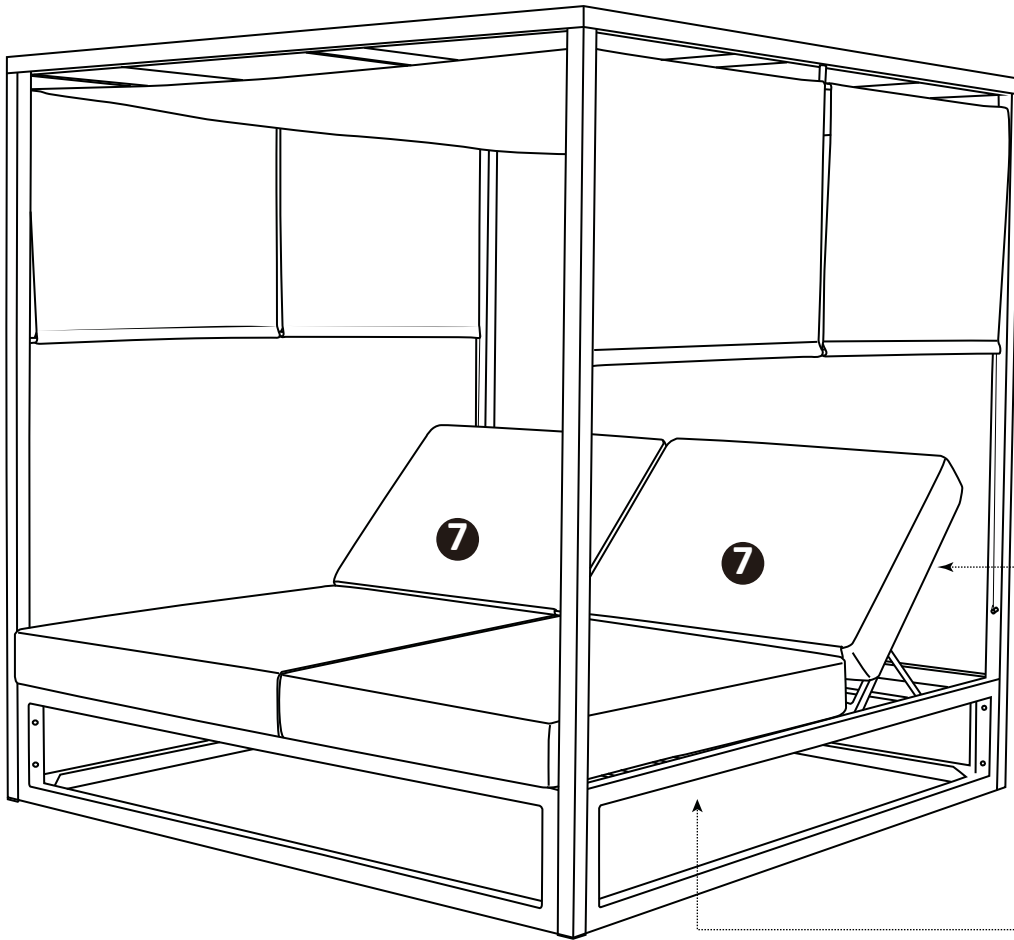
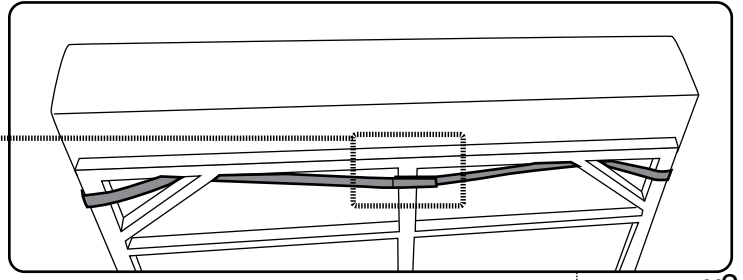
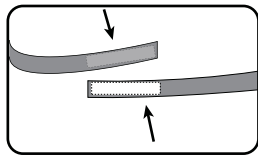

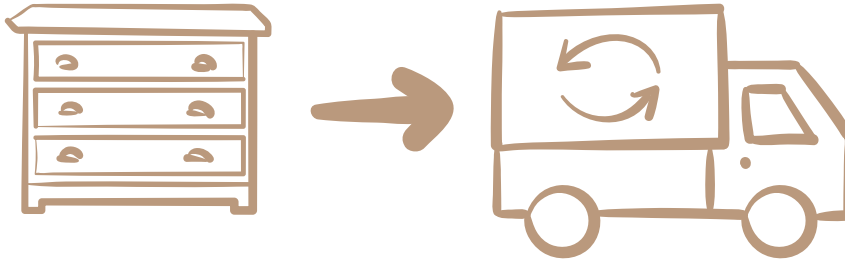

FR : Les produits Maisons du Monde sont conçus pour faire vivre votre maison et la réinventer, au gré de vos envies. Lorsque vous ferez le choix de remplacer ce meuble, contactez une association qui pourra lui donner une 2<sup>ème</sup> vie ou rapportez le dans un point de collecte pour qu'il puisse être recyclé.

En France, l'éco-organisme Eco-mobilier organise la collecte, le recyclage et la valorisation des meubles en fin de vie. Pour géolocaliser un point de collecte près de chez vous, rendez-vous sur [eco-mobilier.fr](http://eco-mobilier.fr)

EN : Maisons du Monde products are designed for you to brighten up and reinvent your home any time it takes your fancy. When you decide to replace your furniture, please contact a charity which could give it a second life, or take it to a waste sorting facility for it to be recycled.

IT : I prodotti Maisons du Monde sono pensati per far vivere la tua casa e reinventarla in base alle tue esigenze. Quando deciderai di sostituire questo mobile, contatta un'associazione che potrà offrirti una seconda vita, oppure portalo in un centro di raccolta affinché possa essere riciclato.

ES : Los productos Maisons du Monde están diseñados para dar vida a tu hogar y reinventarlos cómo y cuándo prefieras. Cuando decidas cambiar un mueble, ponte en contacto con una asociación que pueda darle una segunda vida o llévalo a un punto de recogida para que pueda ser reciclado.

CAT : Els productes Maisons du Monde s'han dissenyat per gaudir i reinventar la vostra llar, tant com vulgueu. Si voleu canviar aquest moble, poseu-vos en contacte amb una associació que li donarà una segona vida o porteu-lo a un punt de recollida de reciclatge.

DE : Die Maisons du Monde-Produkte sind dazu entworfen, Ihrem Heim Leben zu verleihen und es ganz nach Ihren Wünschen neu zu gestalten. Wenn Sie sich entschließen, das Möbelstück auszuwechseln, setzen Sie sich mit einem Verein in Verbindung, der ihm ein zweites Leben schenken kann, oder bringen Sie es zu einer Sammelstelle, damit es recycelt wird.

PT : Os produtos Maisons du Monde são concebidos para fazer viver a sua casa e para a reinventar, ao sabor dos seus desejos. Quando desejar substituir um móvel, contacte uma associação que lhe possa dar uma 2<sup>a</sup> vida ou leve-o até um ponto de recolha para que possa ser reciclado.

NL : De producten van Maisons du Monde zijn ontworpen om je huis tot leven te wekken en een nieuwe persoonlijke look te geven. Wil je dit meubel vervangen? Breng het dan naar een organisatie die er een tweede leven aan geeft of naar een inzamelpunt zodat het gerecycleerd kan worden.

AR : تم تصميم منتجات Maisons du Monde لكي تضيفي على بيتك روحاً جديدة وتجعلك تعيد اكتشافه وفقاً لخيلاتك. عندما تنوي تبديل هذا الأثاث، فكري في الاتصال بجمعية خيرية يمكنها إعادة استعماله أو ضعه في نقطة تجميع حتى تتم رسكاته.